

- Excellent high frequency characteristics
Isolation: Min. 65dB (at 900 MHz)
Insertion loss: Max. 1.0 (at 900 MHz)
- Wide selection
Characteristic impedance: 50 Ω type and 75 Ω type
Coil: Single side stable and latching type
- 1 A 24 V DC switching capacity
- Sealed construction for automatic cleaning
- High sensitivity 350W (1 Form C) in small size

SPECIFICATIONS

Contact

Arrangement	1 Form C, 2 Form C		
Contact material	Gold-clad silver		
Initial contact resistance, max. (By voltage drop 6 V DC 1 A)	100 mΩ		
Rating (resistive)	Max. switching power	24 W	
	Max. switching voltage	24 V DC	
	Max. switching current	1 A	
	Nominal switching capacity	1 A 24 V DC	
High frequency characteristics (at 900 MHz)		50 Ω	75 Ω
	Isolation	Min. 65 dB	Min. 65 dB
	Insertion loss	Max. 1 dB	Max. 1 dB
	V.S.W.R.	Max. 1.2	Max. 2.0
Expected life (min. operations)	Mechanical	5×10 ⁶	
	Electrical 1 A 24 V DC	10 ⁵	

Coil (polarized) (at 25°C, 68°F)

	1 Form C	2 Form C
Single side stable	350 mW	400 mW
1 coil latching	175 mW	200 mW
2 coil latching	350 mW	400 mW

Characteristics

Initial insulation resistance* ¹	Min. 100 MΩ at 500 V DC	
Initial breakdown voltage* ²	Between open contacts	1,000 Vrms
	Between contacts and coil	2,000 Vrms
	Between contacts and earth terminal	500 Vrms
Operate time* ³ (at nominal voltage)	Approx. 10 ms	
Release time* ³ (at nominal voltage)(without diode)	Approx. 5 ms	
Set time* ³ (at nominal voltage)	Approx. 7 ms	
Reset time* ³ (at nominal voltage)	Approx. 7 ms	
Temperature rise (at 20°C)	Max. 55°C with nominal coil voltage across coil and at nominal switching capacity	
Shock resistance	Functional* ⁴	Min. 196 m/s ² {20 G}
	Destructive* ⁵	Min. 980 m/s ² {100 G}
Vibration resistance	Functional* ⁶	10 to 55 Hz at double amplitude of 2 mm
	Destructive	10 to 55 Hz at double amplitude of 2 mm
Conditions for operation, transport and storage (Not freezing and condensing at low temperature)	Ambient temp.	-50°C to 60°C -58°F to 140°F
	Humidity	5 to 85%R.H.
Unit weight	1 C type	Approx. 8 g .282 oz
	2 C type	Approx. 10 g .353 oz

Remarks

- * Specifications will vary with foreign standards certification ratings.
- *¹ Measurement at same location as "Initial breakdown voltage" section
- *² Detection current: 10mA
- *³ Excluding contact bounce time
- *⁴ Half-wave pulse of sine wave: 11ms; detection time: 10μs
- *⁵ Half-wave pulse of sine wave: 6ms
- *⁶ Detection time: 10μs

TYPICAL APPLICATIONS

- Measuring instrument
- Testing equipment
- CATV converter
- Audio visual equipment
- TV game set

ORDERING INFORMATION

Ex. RG 1 T L 5V			
Contact arrangement	Characteristic impedance	Operating function	Coil voltage
1:1 Form C 2:2 Form C	Nil: 75 Ω T: 50 Ω	Nil: Single side stable L: 1 coil latching L2: 2 coil latching	DC: 3, 5, 6, 9, 12, 24, 48 V

Note: Standard packing; Carton: 50 pcs. Case 500 pcs.

RG

TYPES ANE COIL DATA (at 20°C 68°F)

1 Form C

Single side stable

Part No.	Nominal voltage V DC	Pick-up voltage, max. V DC	Drop-out voltage, min. V DC	Coil resistance, Ω ($\pm 10\%$)	Nominal operating current, mA	Nominal operating power, mW	Maximum allowable voltage, V DC (40°C 104°F)
RG1-3V RG1T-3V	3	2.4	0.3	25.7	117	350	3.6
RG1-5V RG1T-5V	5	4.0	0.5	71.4	70	350	6.0
RG1-6V RG1T-6V	6	4.8	0.6	103	58.3	350	7.2
RG1-9V RG1T-9V	9	7.2	0.9	231	38.9	350	10.8
RG1-12V RG1T-12V	12	9.6	1.2	411	29.2	350	14.4
RG1-24V RG1T-24V	24	19.2	2.4	1,646	14.6	350	28.8
RG1-48V RG1T-48V	48	38.4	4.8	6,583	7.3	350	57.6

1 coil latching

Part No.	Nominal voltage V DC	Set and reset voltage, V DC (max.)	Coil resistance, Ω ($\pm 10\%$)	Nominal operating current, mA	Nominal operating power, mW	Maximum allowable voltage, V DC (40°C 104°F)
RG1-L-3V RG1T-L-3V	3	2.4	51.4	58.3	175	3.6
RG1-L-5V RG1T-L-5V	5	4.0	142.8	35	175	6.0
RG1-L-6V RG1T-L-6V	6	4.8	206	29.2	175	7.2
RG1-L-9V RG1T-L-9V	9	7.2	462	19.4	175	10.8
RG1-L-12V RG1T-L-12V	12	9.6	822	14.6	175	14.4
RG1-L-24V RG1T-L-24V	24	19.2	3,292	7.3	175	28.8
RG1-L-48V RG1T-L-48V	48	38.4	13,166	3.6	175	57.6

2 coil latching

Part No.	Nominal voltage V DC	Set and reset voltage, V DC (max.)	Coil resistance, Ω ($\pm 10\%$)		Nominal operating current, mA	Nominal operating power, mW	Maximum allowable voltage, V DC (40°C 104°F)
			Coil 1	Coil 2			
RG1-L2-3V RG1T-L2-3V	3	2.4	25.7	25.7	117	350	3.6
RG1-L2-5V RG1T-L2-5V	5	4.0	71.4	71.4	70	350	6.0
RG1-L2-6V RG1T-L2-6V	6	4.8	103	103	58.3	350	7.2
RG1-L2-9V RG1T-L2-9V	9	7.2	231	231	38.9	350	10.8
RG1-L2-12V RG1T-L2-12V	12	9.6	411	411	29.2	350	14.4
RG1-L2-24V RG1T-L2-24V	24	19.2	1,646	1,646	14.6	350	28.8
RG1-L2-48V RG1T-L2-48V	48	38.4	6,583	6,583	7.3	350	57.6

2 Form C

Single side stable

Part No.	Nominal voltage V DC	Pick-up voltage, max. V DC	Drop-out voltage, min. V DC	Coil resistance, Ω ($\pm 10\%$)	Nominal operating current, mA	Nominal operating power, mW	Maximum allowable voltage, V DC (40°C 104°F)
RG2-3V RG2T-3V	3	2.4	0.3	22.5	133	400	3.6
RG2-5V RG2T-5V	5	4.0	0.5	62.5	80	400	6.0
RG2-6V RG2T-6V	6	4.8	0.6	90	66.7	400	7.2
RG2-9V RG2T-9V	9	7.2	0.9	202.5	44.4	400	10.8
RG2-12V RG2T-12V	12	9.6	1.2	360	33.3	400	14.4
RG2-24V RG2T-24V	24	19.2	2.4	1,440	16.7	400	28.8
RG2-48V RG2T-48V	48	38.4	4.8	5,760	8.3	400	57.6

1 coil latching

Part No.	Nominal voltage V DC	Set and reset voltage, V DC (max.)	Coil resistance, Ω (±10%)	Nominal operating current, mA	Nominal operating power, mW	Maximum allowable voltage, V DC (40°C 104°F)
RG2-L-3V RG2T-L-3V	3	2.4	45	66.7	200	3.6
RG2-L-5V RG2T-L-5V	5	4.0	125	40	200	6.0
RG2-L-6V RG2T-L-6V	6	4.8	180	33.3	200	7.2
RG2-L-9V RG2T-L-9V	9	7.2	405	22.2	200	10.8
RG2-L-12V RG2T-L-12V	12	9.6	720	16.7	200	14.4
RG2-L-24V RG2T-L-24V	24	19.2	2,880	8.3	200	28.8
RG2-L-48V RG2T-L-48V	48	38.4	11,520	4.2	200	57.6

2 coil latching

Part No.	Nominal voltage V DC	Set and reset voltage, V DC (max.)	Coil resistance, Ω (±10%)		Nominal operating current, mA	Nominal operating power, mW	Maximum allowable voltage, V DC (40°C 104°F)
			Coil 1	Coil 2			
RG2-L2-3V RG2T-L2-3V	3	2.4	22.5	22.5	133	400	3.6
RG2-L2-5V RG2T-L2-5V	5	4.0	62.5	62.5	80	400	6.0
RG2-L2-6V RG2T-L2-6V	6	4.8	90	90	66.7	400	7.2
RG2-L2-9V RG2T-L2-9V	9	7.2	203	202.5	44.4	400	10.8
RG2-L2-12V RG2T-L2-12V	12	9.6	360	360	33.3	400	14.4
RG2-L2-24V RG2T-L2-24V	24	19.2	1,440	1,440	16.7	400	28.8
RG2-L2-48V RG2T-L2-48V	48	38.4	5,760	5,760	8.3	400	57.6

DIMENSIONS

mm inch

1 Form C type

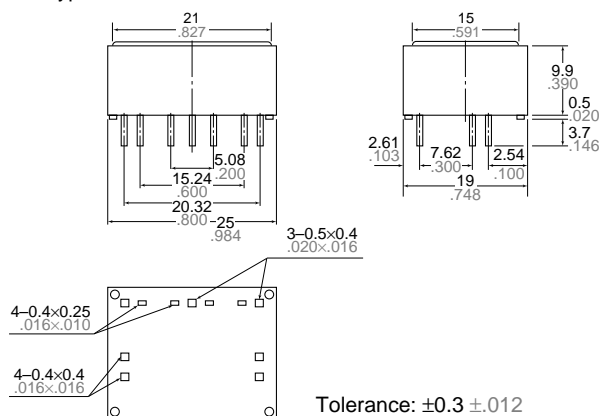

PC board pattern (Copper-side view)

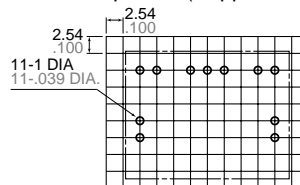

Tolerance: ±0.1 ±0.004

Schematic (Bottom view)

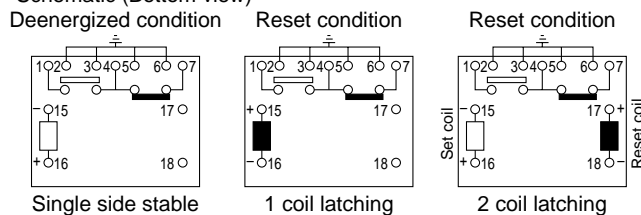

PC board pattern (Copper-side view)

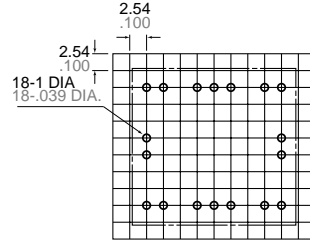
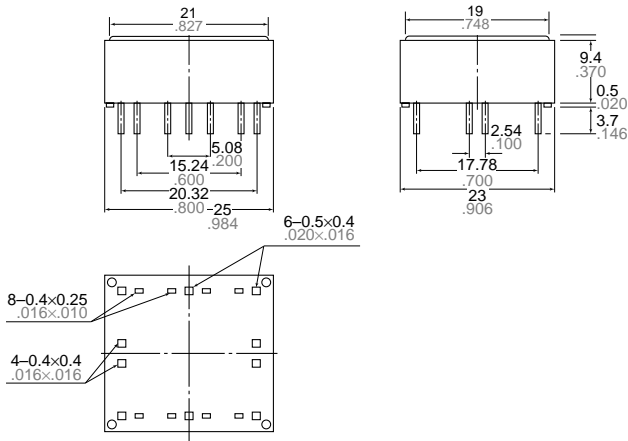

Tolerance: $\pm 0.1 \pm .004$

General tolerance: $\pm 0.3 \pm .012$

Schematic (Bottom view)

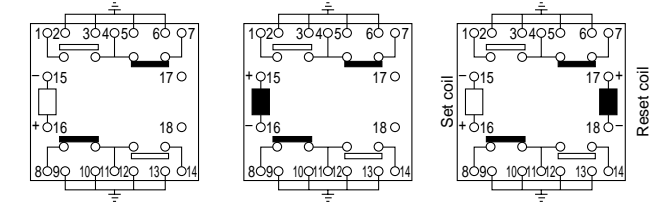

Single side stable Deenergized condition 1 coil latching Reset condition 2 coil latching Reset condition

REFERENCE DATA

1. Isolation

RG2-12V
75 Ω characteristic impedance

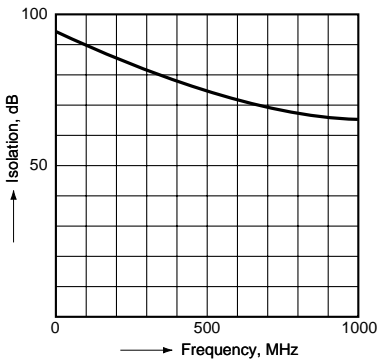

RG2T-12V
50 Ω characteristic impedance

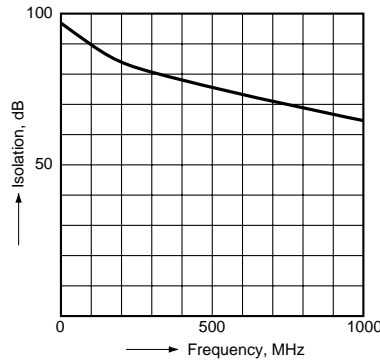

2. Insertion loss

RG2-12V
75 Ω characteristic impedance

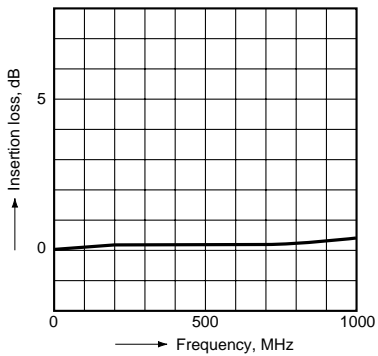

RG2T-12V
50 Ω characteristic impedance

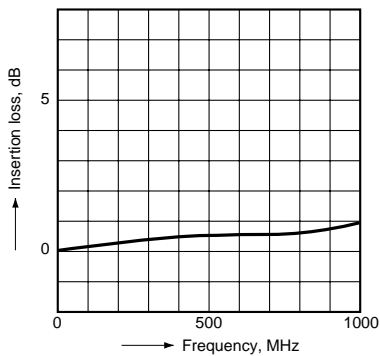

3. Return loss

RG2-12V
75 Ω characteristic impedance

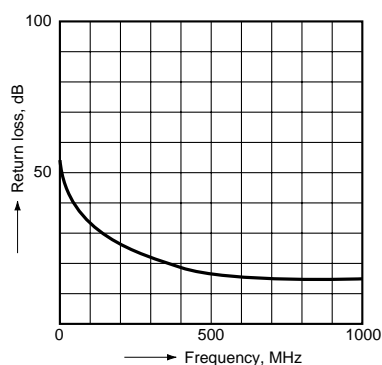

RG2T-12V
50 Ω characteristic impedance

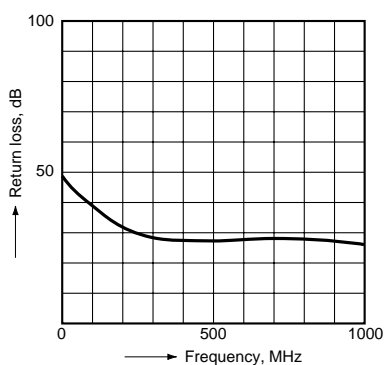

4-(1). Operate and release time (1C)
RG1-12V 6 pcs.

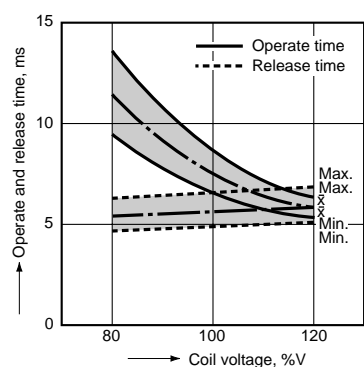

4-(2). Set and reset time (1C)
RG1-L2-12V 6 pcs.

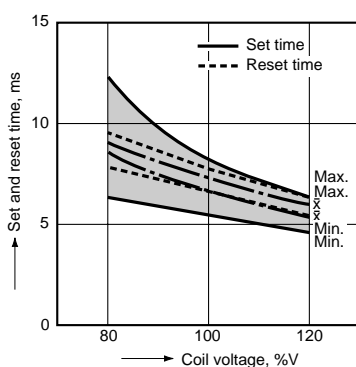

4-(3). Operate and release time
(Without diode) (2C)
RG2-12V 6 pcs.

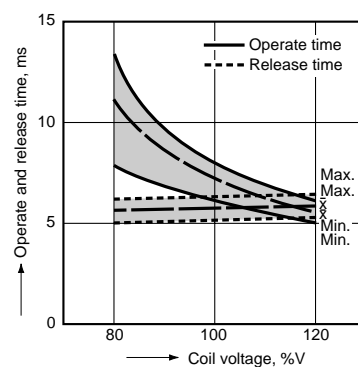

4-(4). Set and reset time (2C)
RG2-L2-12V 6 pcs.

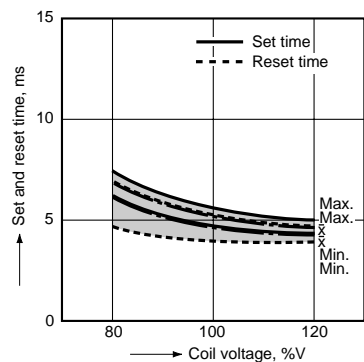

5-(1). Bounce time (2C)
RG2-12V 100 pcs.
Nominal voltage is applied.

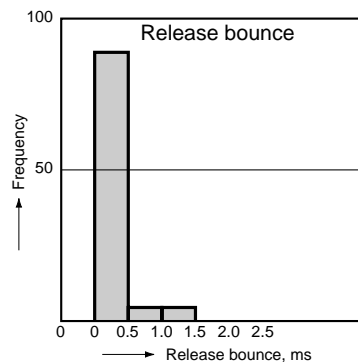
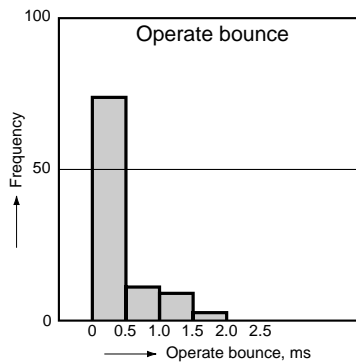

5-(2). Bounce time (2C)
RG2-L2-12V 100 pcs.
Nominal voltage is applied.

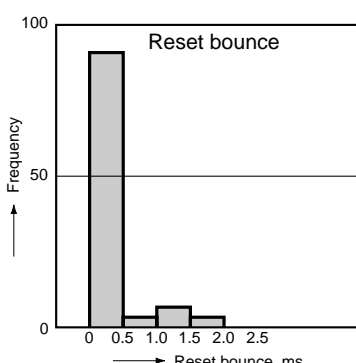
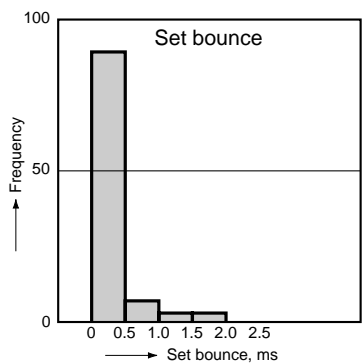

6-(1). Mechanical life (1C)
RG1-12V 12 pcs.

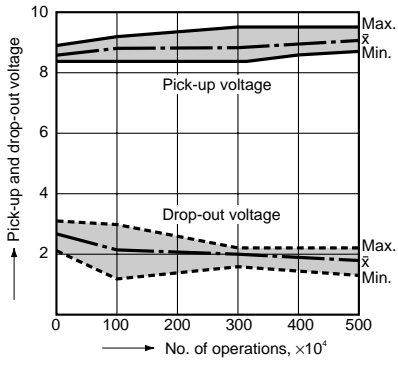

6-(2). Mechanical life (1C latching type)
RG1-L2-12V 6 pcs.

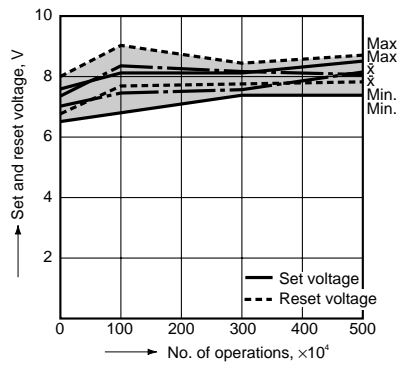

7-(1). Electrical life (10 mA 24 V DC resistive load)
RG2-12V 6 pcs.

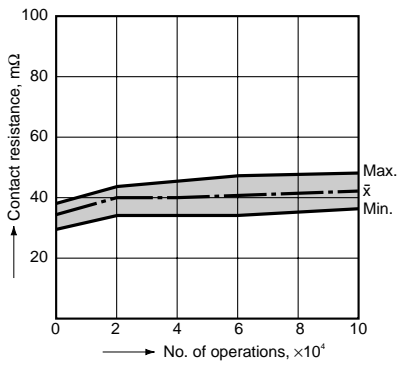

7-(2). Electrical life (1 A 24 V DC resistive load)
RG2-12V 6 pcs.

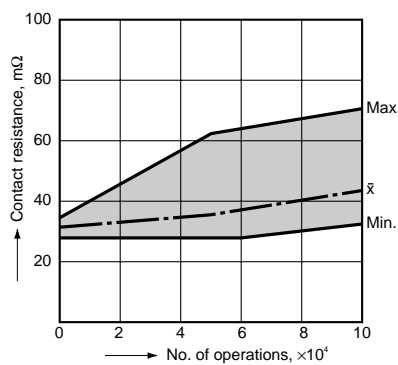

8-(1). Rate of change in pick-up and drop-out voltage (1C)
RG1-12V 5 pcs.

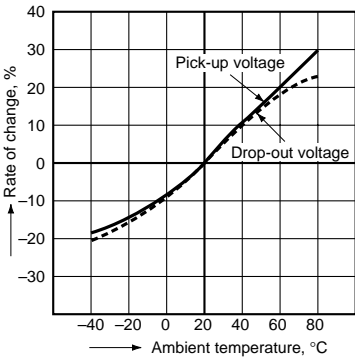

RG1-L2-12V 5 pcs.

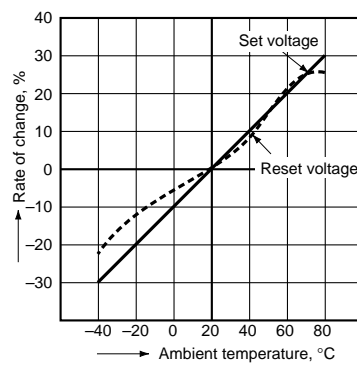

8-(2). Rate of change in pick-up and drop-out voltage (2C)
RG2-12V 5 pcs.

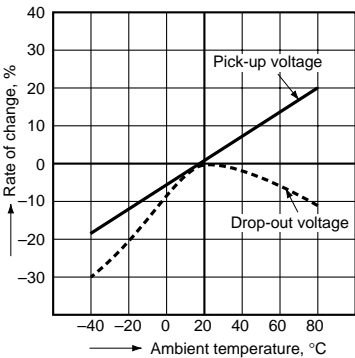

RG2-L2-12V 5 pcs.

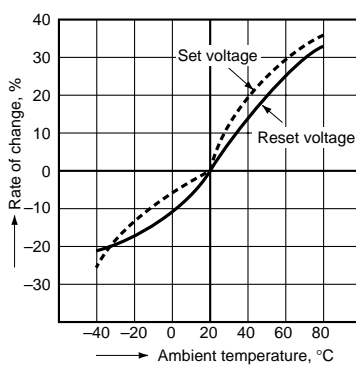

Test condition

mm inch

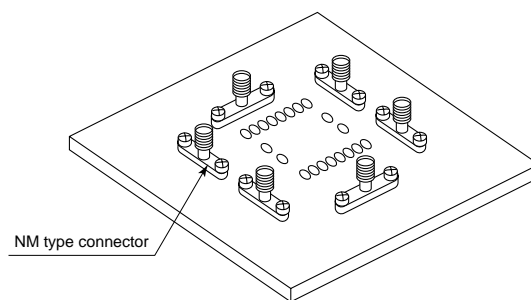
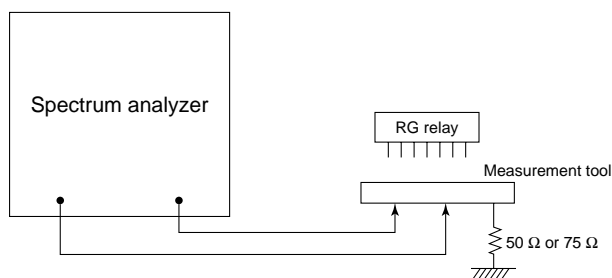

1. Characteristic impedance of all the measuring devices (signal generator and cable) is 50Ω or 75Ω.
2. The PC board for the test is double side copper clad phenolic paper laminate with thickness of 1.6 mm.
3. Grounding terminal holes are plated through.
4. Grounding terminal and one of the coil terminals are soldered to the PC board to be grounded.
5. Connection with measurement instrument is made with semi-rigid cable (Uniform Tube UT 141A) and high frequency NM type connector.

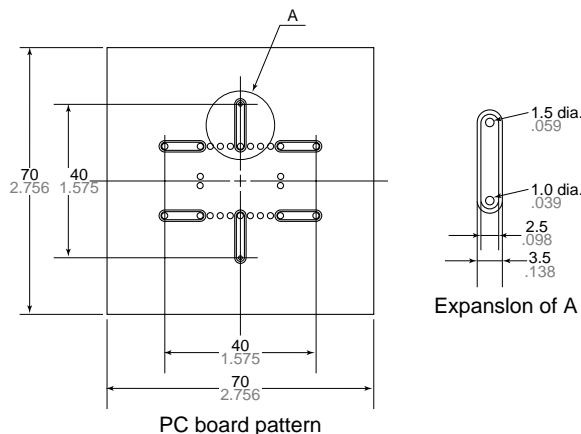

NOTES

1. Soldering

Perform soldering under the conditions below.

- Within 10s at 250°C 482°F
- Within 5s at 300°C 572°F
- Within 3s at 350°C 662°F

2. Counter voltage of DC relays

If input is cut off in DC relays, a counter voltage is developed across the coil as a result of the collapse of the magnetic field. If the coil is used in a transistor circuit, the reverse voltage produced from the coil can cause a serious circuit malfunction.

This counter voltage can be reduced considerably by connecting a capacitor or a diode in parallel with the coil. The level of reduction must be determined either by calculation if the coil data is available or by experiment.

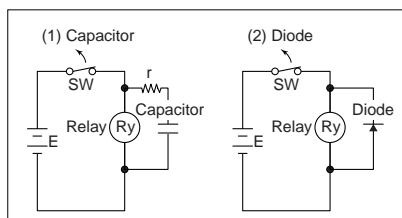

3. Latching relay

In order to assure proper operating regardless of changes in the ambient usage temperature and usage conditions, nominal operating voltage should be applied to the coil for more than 40 ms to set/reset the latching type relay.

For Cautions for Use, see Relay Technical Information (Page 48 to 76).