

NAIS

4,000 V BREAKDOWN VOLTAGE DS RELAYS

DS-BT RELAYS

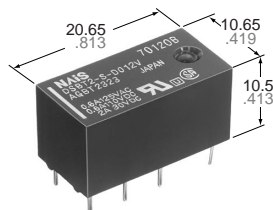

mm inch

FEATURES

- 4,000 V breakdown voltage
- Reinforced insulation between coil and contacts
- Surge voltage withstand: 1500 V FCC Parts 68

SPECIFICATIONS

Contact

Arrangement	2 Form C	2 Form D
Initial contact resistance, max. (By voltage drop 6 V DC 1 A)	50 mΩ	
Contact material	Gold-clad silver	
Rating (resistive load)	Nominal switching capacity	2 A 30 V DC 1 A 30 V DC
	Max. switching power	60 W, 125 VA 30 W, 62.5 VA
	Max. switching voltage	220 V DC, 250 V AC
	Max. switching current	2 A 1 A
	Min. switching capacity**1	10 μA 10 mV DC
Electrical life (min. ope.)	Mechanical (at 180 cpm)	2×10 ⁷ 10 ⁶
	Electrical (at 20 cpm)	2×10 ⁵

**1 This value can change due to the switching frequency, environmental conditions, and desired reliability level, therefore it is recommended to check this with the actual load.

Coil

Arrangement	2 Form C	2 Form D
Nominal operating power	360 mW	540 mW

Remarks

- * Specifications will vary with foreign standards certification ratings.
- *1 Measurement at same location as "Initial breakdown voltage" section
- *2 Detection current: 10mA
- *3 Excluding contact bounce time
- *4 Half-wave pulse of sine wave: 11ms, detection time: 10μs
- *5 Half-wave pulse of sine wave: 6ms
- *6 Detection time: 10μs
- *7 Refer to 5. Conditions for operation, transport and storage mentioned in AMBIENT ENVIRONMENT (Page 61)

Characteristics

Arrangement	2 Form C	2 Form D
Max. operating speed	60 cpm at rated load	
Initial insulation resistance*1	Min. 100 MΩ (at 500 V DC)	
Initial break-down voltage*2	Between open contacts	750 Vrms for 1 min. 500 Vrms for 1 min.
	Between contacts and coil	4,000 Vrms for 1 min.
	Between contacts sets	750 V 500 V
FCC surge voltage between open contacts	1,500 V	
Operate time*3 (at nominal voltage)	Approx. 3 ms	
Release time (without diode)*3 (at nominal voltage)	Approx. 2 ms	
Temperature rise	Max. 65°C	
Vibration resistance	Functional*4	10 to 55 Hz at double amplitude of 3.3 mm
	Destruction*5	10 to 55 Hz at double amplitude of 5 mm
Shock resistance	Functional*6	Min. 294 m/s ² (30 G)
	Destruction	Min. 980 m/s ² (100 G)
Conditions for operation, transport and storage*7 (Not freezing and condensing at low temperature)	Ambient temp.	-40°C to +70°C -40°C to +60°C -40°F to +158°F -40°F to +140°F
	Humidity	5 to 85%R.H.
Unit weight	Approx. 4.0 g 0.14 oz	

TYPICAL APPLICATIONS ORDERING INFORMATION

Modem
Facsimile
Telecommunication equipment

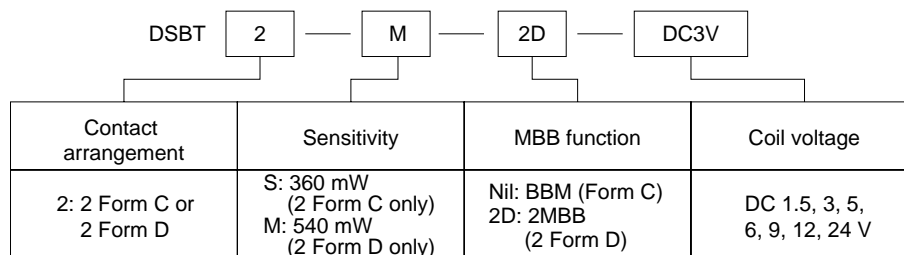

Note: Standard packing; Carton: 25 pcs. Case 1,000 pcs.

TYPES AND COIL DATA (at 20°C 68°F)

1) 2 Form C type

Operating function	Part No.	Coil voltage, V DC	Pick-up voltage, V DC (max.)	Drop-out voltage, V DC (min.)	Nominal operating current, mA (±10%)	Coil resistance, Ω (±10%)	Nominal operating power, mW	Max. allowable voltage, V DC (at 50°C 122°F)
Single side stable	DSBT2-S-DC1.5V	1.5	1.125	0.15	240	6.25	360	1.95
	DSBT2-S-DC3V	3	2.25	0.3	120	25		3.9
	DSBT2-S-DC5V	5	3.75	0.5	72	69.4		6.5
	DSBT2-S-DC6V	6	4.5	0.6	60	100		7.8
	DSBT2-S-DC9V	9	6.75	0.9	40	225		11.7
	DSBT2-S-DC12V	12	9	1.2	30	400		15.6
	DSBT2-S-DC24V	24	18	2.4	15	1,600		31.2

2) 2 Form D type

Operating function	Part No.	Coil voltage, V DC	Pick-up voltage, V DC (max.)	Drop-out voltage, V DC (min.)	Nominal operating current, mA (±10%)	Coil resistance, Ω (±10%)	Nominal operating power, mW	Max. allowable voltage, V DC (at 50°C 122°F)
Single side stable	DSBT2-M-2D-DC1.5V	1.5	1.125	0.15	360	4.2	540	1.8
	DSBT2-M-2D-DC3V	3	2.25	0.3	180	16.7		3.6
	DSBT2-M-2D-DC5V	5	3.75	0.5	108	46.3		6
	DSBT2-M-2D-DC6V	6	4.5	0.6	90	66.7		7.2
	DSBT2-M-2D-DC9V	9	6.75	0.9	60	150		10.8
	DSBT2-M-2D-DC12V	12	9	1.2	45	266.7		14.4
	DSBT2-M-2D-DC24V	24	18	2.4	22.5	1,066.7		28.8

Note: Standard packing Tube: 25 pcs. Case: 1,000 pcs.

DIMENSIONS

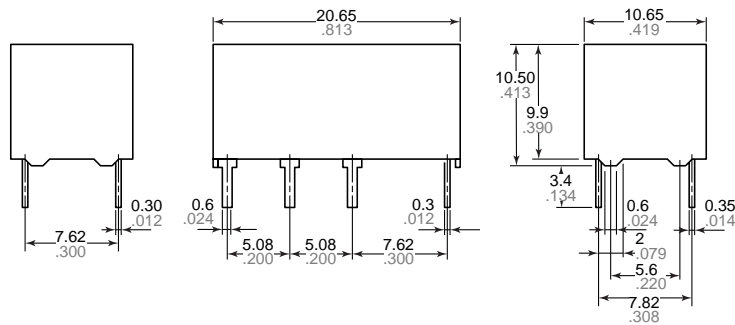

General tolerance: $\pm 0.3 \pm .012$

mm inch
PC board pattern (Bottom view)

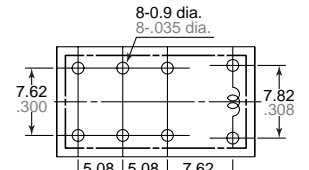

Tolerance: $\pm 0.1 \pm .004$

Schematic (Bottom view)

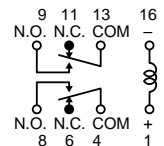

REFERENCE DATA

1. Mechanical life test
Tested sample: DSBT2-S-DC5V, 10 pcs.
Coil applied voltage: 5 V DC
Operating frequency: 30 cpm

Change of pick-up and drop-out voltage

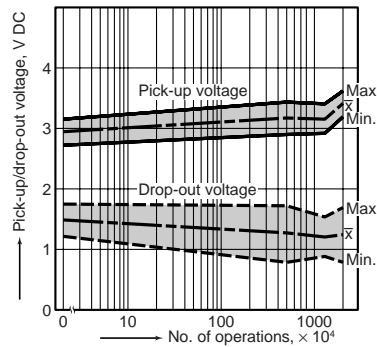

Change of contact resistance

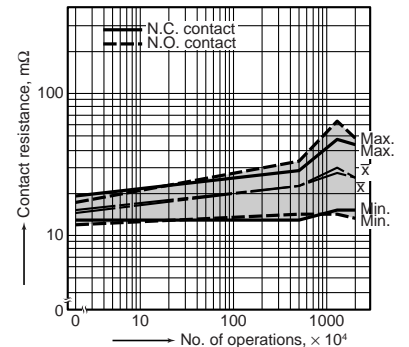

DS-BT

2. Electrical life test (resistive)

Tested sample: DSBT2-S-DC12V, 6 pcs.
Condition: 2 A 30 V DC resistive load, 30 cpm
Circuit

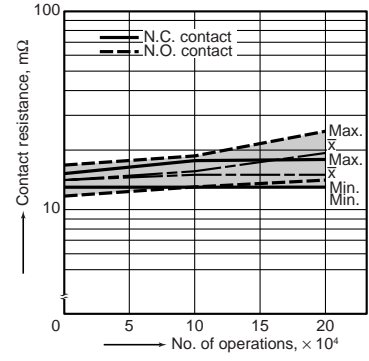
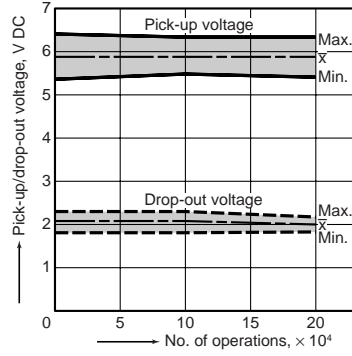
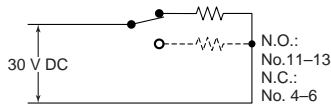

3. Coil temperature rise

Tested sample: DSBT2-S-DC12V, 5 pcs.
Measured portion: Inside the coil

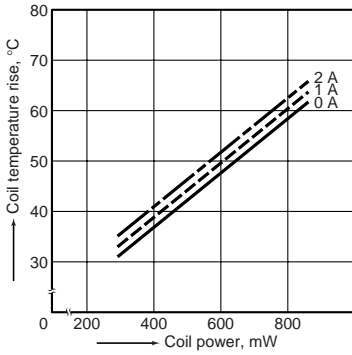

4. Operate and release time characteristics

Tested sample: DSBT2-S-DC5V, 10 pcs.
Ambient temperature: 23°C 73°F

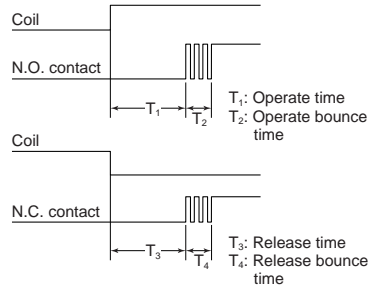

Without diode (T₁)

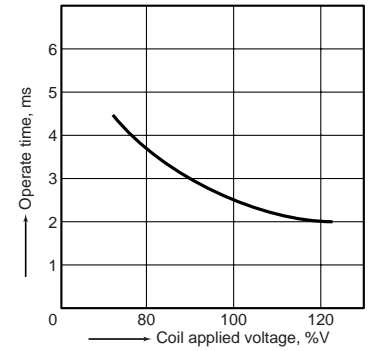

Without diode (T₂)

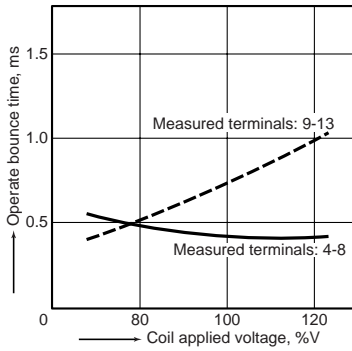

Without diode (T₃)

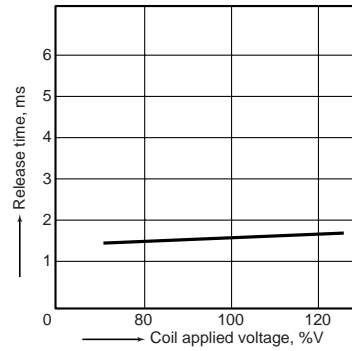

Without diode (T₄)

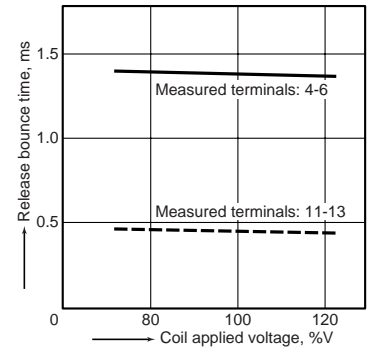

5. Distribution of pick-up and drop-out voltage

Tested sample: DSBT2-S-DC5V, 50 pcs.
Pick-up voltage

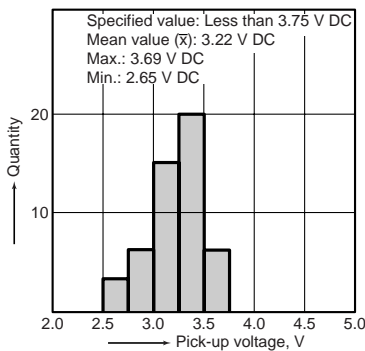

Drop-out voltage

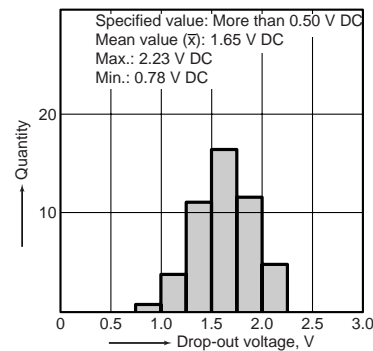

6. Distribution of breakdown voltage

(between contacts and coil)
Tested sample: DSBT2-S-DC5V, 100 pcs.

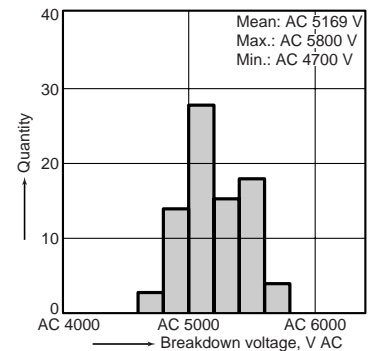

For Cautions for Use, see Relay Technical Information (Page 48 to 76).