

# NAIS

## SMALL SIZED POWER RELAY

# JZ-RELAYS

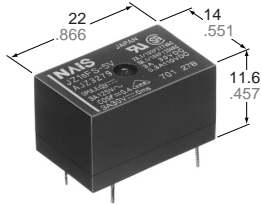

mm inch

### FEATURES

- Small sized flat type: 22×14×11.6 mm .866×.551×.457 inch
- High dielectric withstanding: 10,000 V surge in ms between coil and contact
- High electrical noise immunity
- High sensitivity type available
- VDE, TÜV, SEMKO also approved

### SPECIFICATIONS

#### Contact

Type	Standard type	High sensitivity type	Standard TV-5 type	TV-5 High sensitivity type	
Arrangement	1 Form A				
Contact material	Silver alloy				
Initial contact resistance, max. (By voltage drop 6 V DC 1 A)	100 mΩ				
Rating (resistive)	Nominal switching capacity	5 A 125 V AC 5 A 30 V DC	3 A 125 V AC 3 A 30 V DC	8 A 125 V AC 5 A 30 V DC	
	Max. switching power	150 W, 750 VA	90 W, 500 VA	150 W, 1,250 VA	
	Max. switching voltage	250 V AC, 110 V DC (0.3 A)			
	Max. switching current	5 A	3 A	8 A	
Expected life (min. operations)	Mechanical (at 180 cpm)	5 × 10 <sup>6</sup>			
	Electrical (at 20 cpm)	10 <sup>5</sup> (at nominal operating capacity)	2 × 10 <sup>5</sup> (3 A 125 V AC) 10 <sup>5</sup> (3 A 30 V DC)	10 <sup>5</sup> (at nominal operating capacity)	5 × 10 <sup>4</sup> (8 A 125 V AC) 10 <sup>5</sup> (5 A 30 V DC)

#### Coil (at 20°C 68°F)

Standard type	Nominal operating power	400 mW
High sensitivity type	Nominal operating power	200 mW

#### Remarks

- \* Specifications will vary with foreign standards certification ratings.
- \*<sup>1</sup> Measurement at same location as "Initial breakdown voltage" section
- \*<sup>2</sup> Detection current: 10mA
- \*<sup>3</sup> Wave is standard shock voltage of ±1.2 × 50μs according to JEC-212-1981
- \*<sup>4</sup> Excluding contact bounce time
- \*<sup>5</sup> Half-wave pulse of sine wave: 11ms; detection time: 10μs
- \*<sup>6</sup> Half-wave pulse of sine wave: 6ms
- \*<sup>7</sup> Detection time: 10μs
- \*<sup>8</sup> Refer to 5. Conditions for operation, transport and storage mentioned in AMBIENT ENVIRONMENT (Page 61).

#### Characteristics

(at 25°C 77°F, 50% Relative humidity)

Max. operating speed	20 cpm	
Initial insulation resistance* <sup>1</sup>	Min. 100 MΩ at 500 V DC	
Initial breakdown voltage* <sup>2</sup>	Between open contacts	750 Vrms for 1 min.
	Between contacts and coil	2,000 Vrms for 1 min.
Surge voltage between contact and coil* <sup>3</sup>	Min. 10,000 V	
Operate time* <sup>4</sup> (at nominal voltage)	Approx. 4 ms	
Release time* <sup>4</sup> (without diode) (at nominal voltage)	Approx. 2 ms	
Temperature rise (ambient temperature at 70°C)	Max. 45°C at max. switching current	
Shock resistance	Functional* <sup>5</sup>	Min. 98 m/s <sup>2</sup> {10 G}
	Destructive* <sup>6</sup>	Min. 980 m/s <sup>2</sup> {100 G}
Vibration resistance	Functional* <sup>7</sup>	98 m/s <sup>2</sup> {10 G}, 10 to 55 Hz at double amplitude of 1.6 mm
	Destructive	117.6 m/s <sup>2</sup> {12 G}, 10 to 55 Hz at double amplitude of 2 mm
Conditions for operation, transport and storage* <sup>8</sup> (Not freezing and condensing at low temperature)	Ambient temp.	-40°C to +70°C -40°F to +158°F
	Humidity	5 to 85% R.H.
Unit weight	Approx. 7 g .25 oz	

### TYPICAL APPLICATIONS

- Microwave oven (fan, inside lamp)
- Machineris which need electrical noise resistance and surge resistance, (Ex. hot-water heater)

### ORDERING INFORMATION

Ex. JZ 1a F S — 9 V — TV

Contact arrangement	Protective construction	Type classification	Coil voltage (DC)	Type classification
1a: 1 Form A	F: Flux-resistant type	Nil: Standard (400 mW) S: High sensitivity (200 mW)	5, 6, 9, 12, 18, 24 V	Nil: UL/CSA/VDE recognized type TV: TV-5 rated type

Note: Standard packing Carton: 100 pcs. Case: 500 pcs.  
UL/CSA, TV-5 (only for TV type) approved type is standard.

**TYPES AND COIL DATA (at 20°C 68°F)**

**1) Standard type**

Part No.	Nominal voltage, V DC	Pick-up voltage, V DC (max.)	Drop-out voltage, V DC (min.)	Coil resistance, Ω (±10%)	Nominal operating current, mA	Nominal operating power, mW	Max. allowable voltage, at 70°C, V DC
JZ1aF-5V	5	3.5	0.25	62.5	80	400	5.5
JZ1aF-6V	6	4.2	0.3	90	67	400	6.6
JZ1aF-9V	9	6.3	0.45	202	45	400	9.9
JZ1aF-12V	12	8.4	0.6	360	33	400	13.2
JZ1aF-18V	28	12.6	0.9	810	22	400	19.8
JZ1aF-24V	24	16.8	1.2	1,440	17	400	26.4

**2) High sensitivity type**

Part No.	Nominal voltage, V DC	Pick-up voltage, V DC (max.)	Drop-out voltage, V DC (min.)	Coil resistance, Ω (±10%)	Nominal operating current, mA	Nominal operating power, mW	Max. allowable voltage, at 70°C, V DC
JZ1aFS-5V	5	4	0.25	125	40	200	6.5
JZ1aFS-6V	6	4.8	0.3	180	33	200	7.8
JZ1aFS-9V	9	7.2	0.45	405	22	200	11.7
JZ1aFS-12V	12	9.6	0.6	720	17	200	15.6
JZ1aFS-18V	18	14.4	0.9	1,620	11	200	23.4
JZ1aFS-24V	24	19.2	1.2	2,880	8.3	200	31.2

**DIMENSIONS**

mm inch

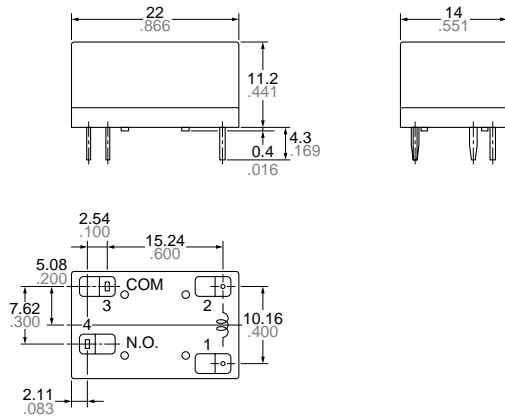

PC board pattern (Copper-side view)

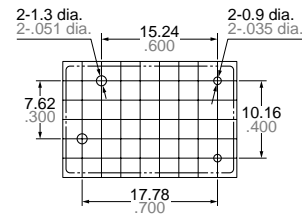

Tolerance: ±0.1±.004

General tolerance: ±0.3 ±.012

**REFERENCE DATA**

• Not TV-5 rated type

1. Max. switching power (AC resistive load)

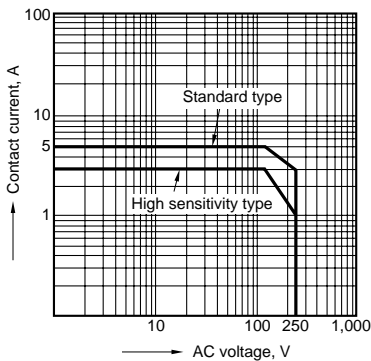

2.-(1) Operate/Release time (Standard type)

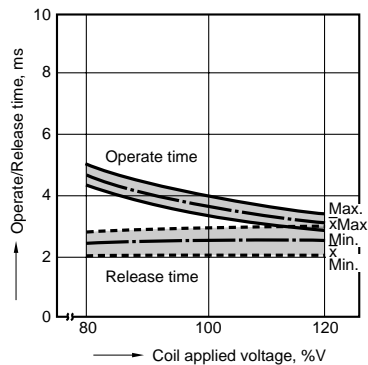

2.-(2) Operate/Release time (High sensitivity type)

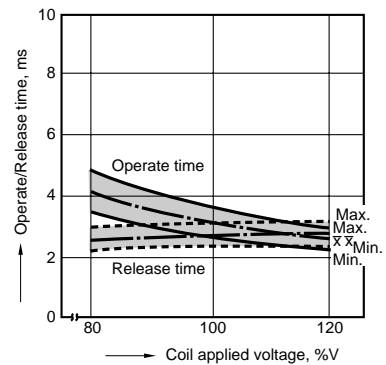

3. Coil temperature rise

Point measured: Coil inside  
Contact current: 3 A

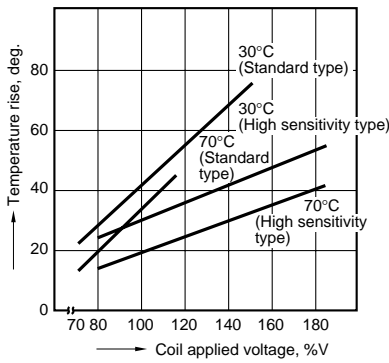

4.-(1) Ambient temperature vs. coil applied voltage (Standard type)

Contact current: 1 A

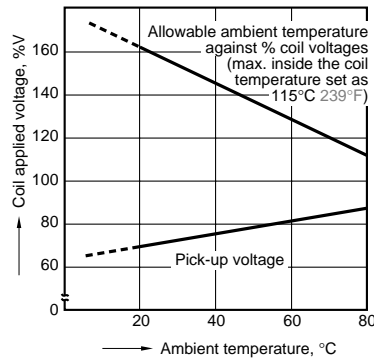

4.-(2) Ambient temperature vs. coil applied voltage (High sensitivity type)

Contact current: 1 A

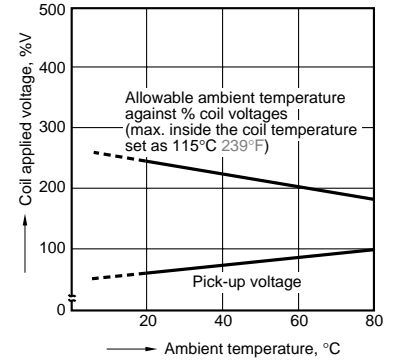

5. Electrical life (load test: fan motor, turntable motor and inside lamp of microwave oven)

Tested sample: JZ1aFS-24V, 6 pcs.  
Load: 100 V AC 0.5 A; Rush current: 2.5 A  
Operation frequency: 4 times/min.  
(ON:OFF = 3s:12s)  
With coil diode protection  
Ambient temperature: 70°C 158°F

Circuit

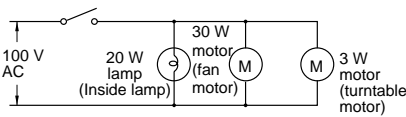

Change of pick-up and drop-out voltage

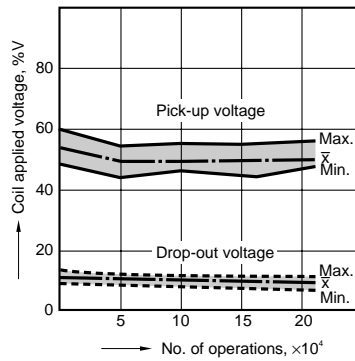

Change of contact resistance

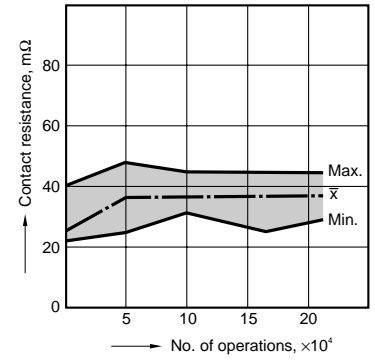

6. Noise resistance

Tested sample: JZ1aFS-24V

Circuit

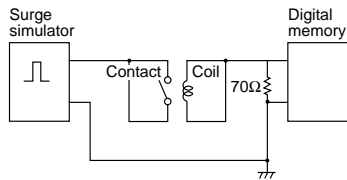

Noise wave form

(Applied voltage wave form to the contact)

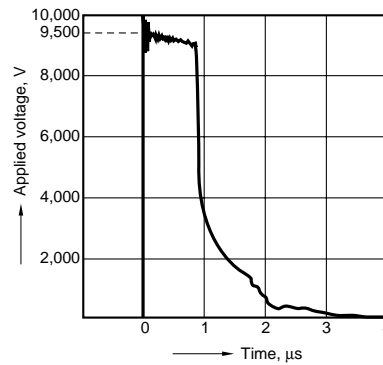

Output wave form

(Output wave form on the coil side)

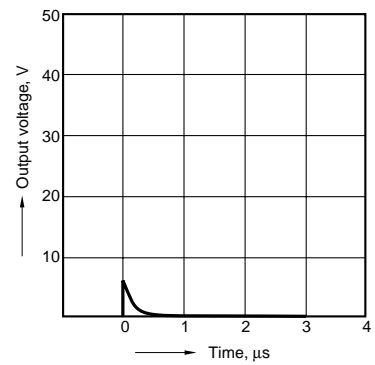

•TV-5 rated type

1. Max. switching power

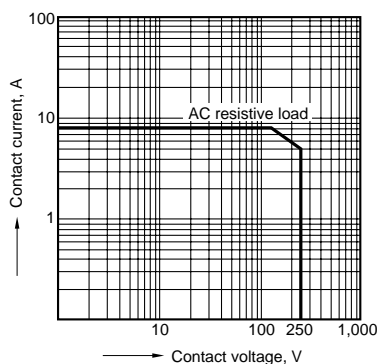

2-(1). Operate/Release time (Standard type)

Sample: JZ1aF-12V-TV

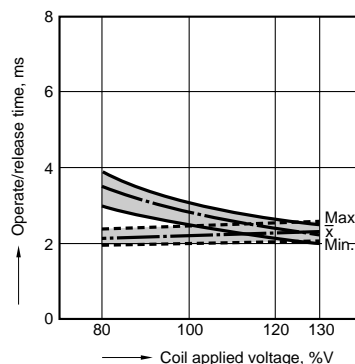

2-(2). Operate/Release time (High sensitivity type)

Sample: JZ1aFS-12V-TV

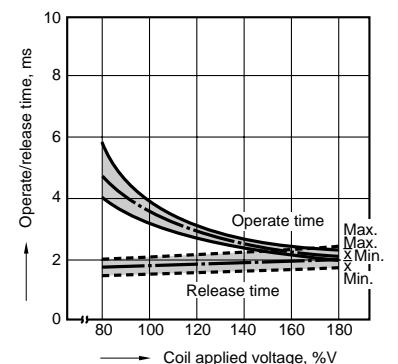

### 3-(1). Coil temperature rise (Standard type)

Sample: JZ1aF-12V-TV  
 Point measured: Coil inside  
 Contact current: 8 A

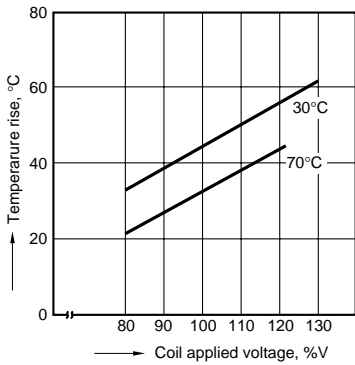

### 3-(2). Coil temperature rise (High sensitivity type)

Sample: JZ1aFS-12V-TV  
 Point measured: Coil inside  
 Contact current: 5 A

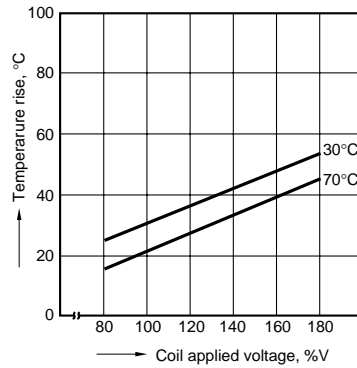

### 4-(1). Ambient temperature vs. coil applied voltage (Standard type)

Sample: JZ1aF-12V-TV

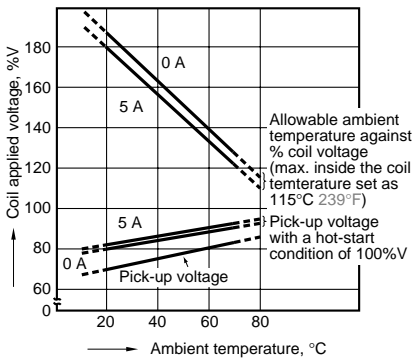

### 4-(2). Ambient temperature vs. coil applied voltage (High sensitivity type)

Sample: JZ1aFS-12V-TV

Contact current: 5 A

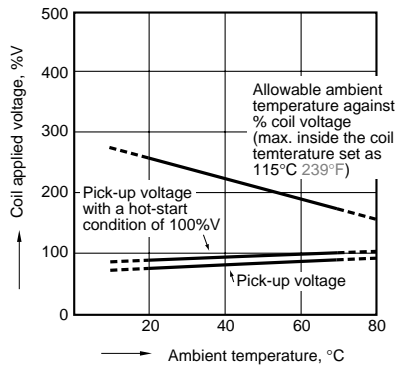

### 5-(1). Electrical life test (TV-5)

Tested sample: JZ1aF-12V-TV, 6 pcs.  
 UL Lamp load test

	Overload	Endurance
Voltage	AC 120 V	AC 120 V
Switching frequency	60 Hz	60 Hz
Current	Inrush: 111 A; Steady: 7.5 A	Inrush: 78 A; Steady: 5.0 A
Operating speed	10 cpm (ON:OFF = 1s:5s)	10 cpm (ON:OFF = 1s:5s)
No. of operations	50 ope.	25,000 ope.

### Change of pick-up and drop-out voltage

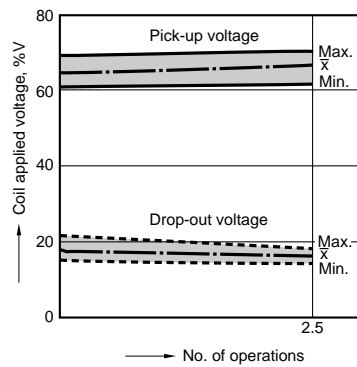

### Change of contact resistance

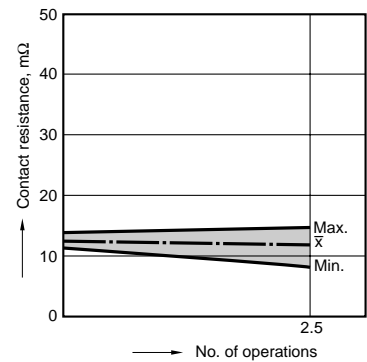

### 5-(2). Electrical life test (Condenser load)

Tested sample: JZ1aF-12V-TV, 6 pcs.  
 Load: DC 17 V 6.4 A, Inrush max. 139 A  
 Operating speed: 20 cpm

(ON:OFF = 1 s:2 s)

Ambient temperature: 27°C 81°F

Circuit:

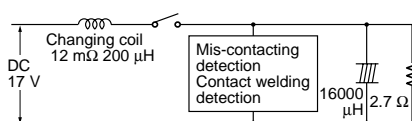

### Change of pick-up and drop-out voltage

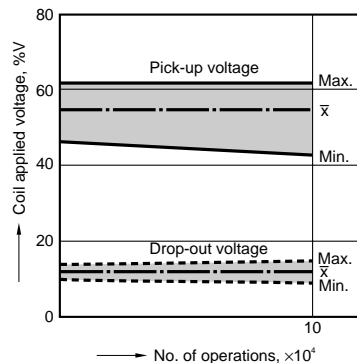

### Change of contact resistance

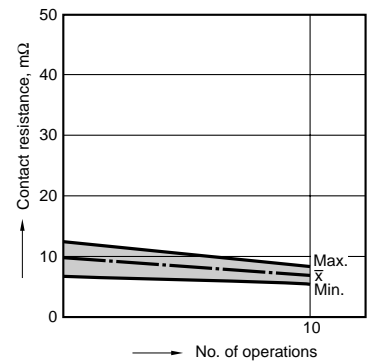

5-(3). Electrical life test (TV power source)

Tested sample: JZ1aF-12V-TV, 10 pcs.

Load: AC 100 V TV power source

Inrush: 100 A max.; Steady: 5.0 A

Operating speed: 20 cpm

(ON:OFF = 1 s:2 s)

Ambient temperature: 40°C 104°F95% R.H.

Circuit:

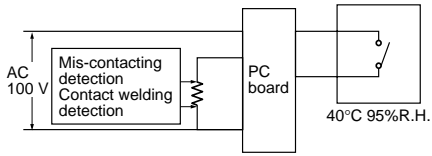

Change of pick-up and drop-out voltage

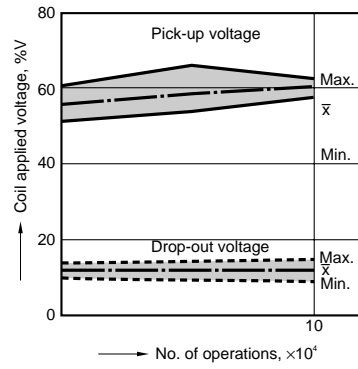

Change of contact resistance

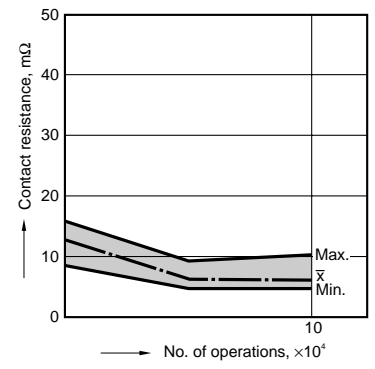

**For Cautions for Use, see Relay Technical Information (Page 48 to 76).**